

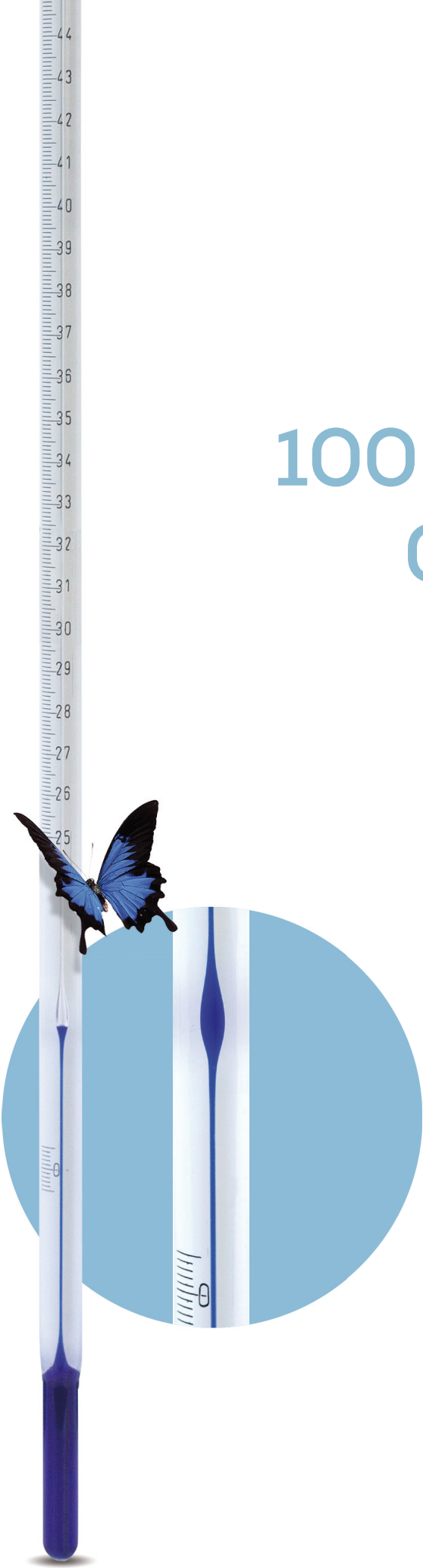

LUDWIG  
SCHNEIDER



# ACCU-SAFE THERMOMETERS



# ACCU-SAFE 100 % PRECISION 0 % MERCURY

ECO-FRIENDLY,  
HEALTH-FRIENDLY AND  
HIGH-PRECISION  
LABORATORY THERMOMETERS

With **ACCU-SAFE** thermometers from Ludwig Schneider you measure precisely and reliably **WITHOUT MERCURY** from the very start.

#### THE ADVANTAGES FOR MANKIND & ENVIRONMENT:

- + Eco-friendly
- + Non-toxic
- + Harmless
- + Simple cleaning (for example a spill after glass breakage)
- + Suitable for most laboratory thermometers

# TABLE OF CONTENTS

Precision Laboratory Thermometers, <b>Enclosed Scale</b>	4
Precision Laboratory Thermometers, <b>Stemform</b>	5
Precision Laboratory Thermometers, <b>Stemform, ASTM</b>	6–7
Precision Laboratory Thermometers, <b>Stemform, ASTM-Like</b>	8–13
Precision Thermometers, <b>Stemform, ISO-R 1770 / BS 1704</b>	14
Precision Laboratory Thermometers, <b>Stemform, IP</b>	15
Precision Thermometers for <b>Special Applications</b>	16–17
Precision Laboratory Thermometers with <b>DAkkS-calibration</b>	18
Accredited DAkkS-calibration Laboratory for Temperature & Density	19

# PRECISION LABORATORY THERMOMETERS, ENCLOSED SCALE BLUE FILLING, ACCU-SAFE

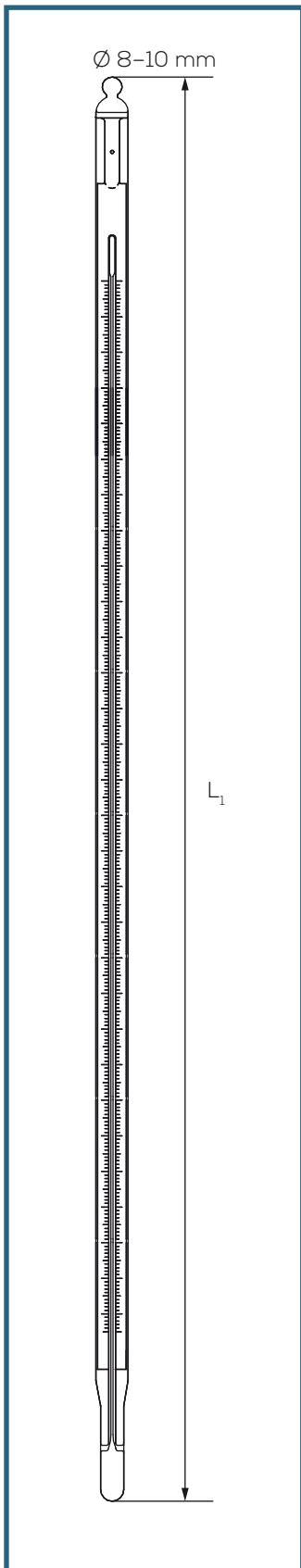

Capillary colourless prismatic, Ø 8-10 mm

- + Made in Germany
- + Suitable for calibration
- + With individual serial number & certificate of conformity
- + Each item packed in square plastic sleeve

Order-No.	Measuring Range in °C	Scale in °C	Tolerance in °C	Total Length in mm (L <sub>1</sub> )	Immersion in mm
1042343S	-10 to +50	0,5	±0,5	220	total
1042344S	-10 to +100	0,5	±0,5	270	total
1042345S	-10 to +150	0,5	±0,5	350	total
1042351S	-10 to +200	0,5	±0,5	450	total
1042604S	-38 to +50	0,2	±0,4	400	total
1042346S	-5 to +50	0,2	±0,3	350	total
1042347S	-5 to +100	0,2	±0,3	420	total
1042352S	-5 to +201	0,2	±0,4	550	total
1042703S	-38 to +50	0,1	±0,3	550	total
1042704S	-30 to +30	0,1	±0,3	400	total
1042353S	-10 to +30	0,1	±0,2	300	total
1042349S	-10 to +50	0,1	±0,2	420	total
1042354S	0 to +100	0,1	±0,2	550	total
1122904S	0 to +51	0,1	±0,2	400	total
1122905S	+47 to +101	0,1	±0,2	400	total
1122906S	+97 to +151	0,1	±0,4	400	total
1122907S	+147 to +201	0,1	±0,4	400	total

### ORDER SUFFIX:

- ...../80 with Safety-coating (FEP)
- ...../03 with Works-calibration certificate
- ...../04 with DAkkS-calibration certificate

Please always indicate the required number of calibration points.

Sample: Order-No.: 1042343S/04/3P = Laboratory Thermometer -10 to +50 °C, including DAkkS-calibration certificate with 3 calibration points

# PRECISION LABORATORY THERMOMETERS, STEMFORM BLUE FILLING, ACCU-SAFE

Capillary white back round, Ø 6–8 mm

- + Made in Germany
- + Suitable for calibration
- + With individual serial number & certificate of conformity
- + Each item packed in square plastic sleeve

Order-No.	Measuring Range in °C	Scale in °C	Tolerance in °C	Total Length in mm (L <sub>1</sub> )	Immersion in mm
1052105S	-38 to +50	0,5	±0,5	320	total
1042373S	-10 to +50	0,5	±0,5	240	total
1042374S	-10 to +100	0,5	±0,5	290	total
1042375S	-10 to +150	0,5	±0,5	370	total
1042380S	-1 to +201	0,5	±0,5	480	total
1042376S	-5 to +50	0,2	±0,3	370	total
1042377S	-5 to +100	0,2	±0,3	440	total
1052303S	-38 to +50	0,1	±0,3	570	total
1042384S	-10 to +30	0,1	±0,2	320	total
1042379S	-10 to +50	0,1	±0,2	440	total
1132004S	0 to +51	0,1	±0,2	420	total
1132005S	+47 to +101	0,1	±0,2	420	total
1132006S	+97 to +151	0,1	±0,4	420	total
1132007S	+147 to +201	0,1	±0,4	420	total

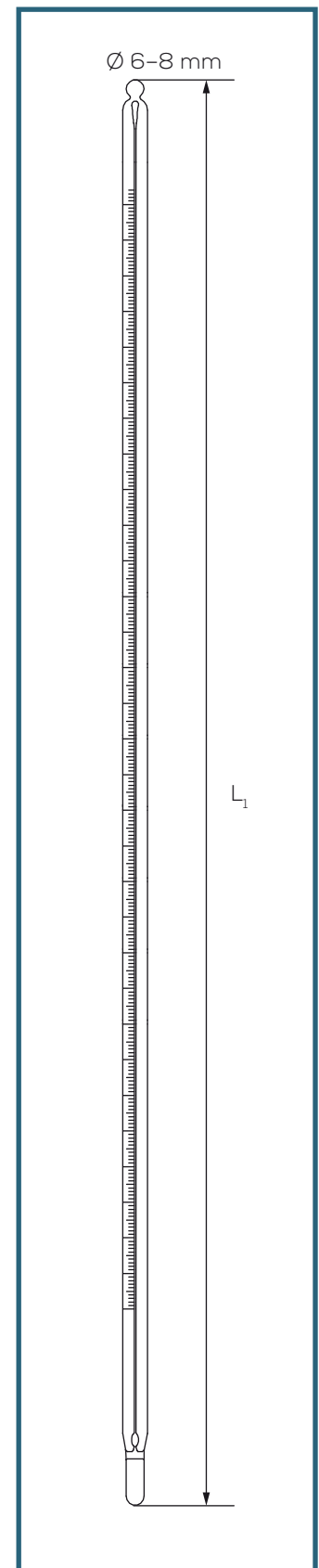

#### ORDER SUFFIX:

- ...../80 with Safety-coating (FEP)
- ...../03 with Works-calibration certificate
- ...../04 with DAkkS-calibration certificate

Please always indicate the required number of calibration points.

Sample: Order-No.: 1052105S/04/3P = Laboratory Thermometer -38 to +50 °C, including DAkkS-calibration certificate with 3 calibration points

# PRECISION LABORATORY THERMOMETERS, STEMFORM, ASTM BLUE FILLING, ACCU-SAFE

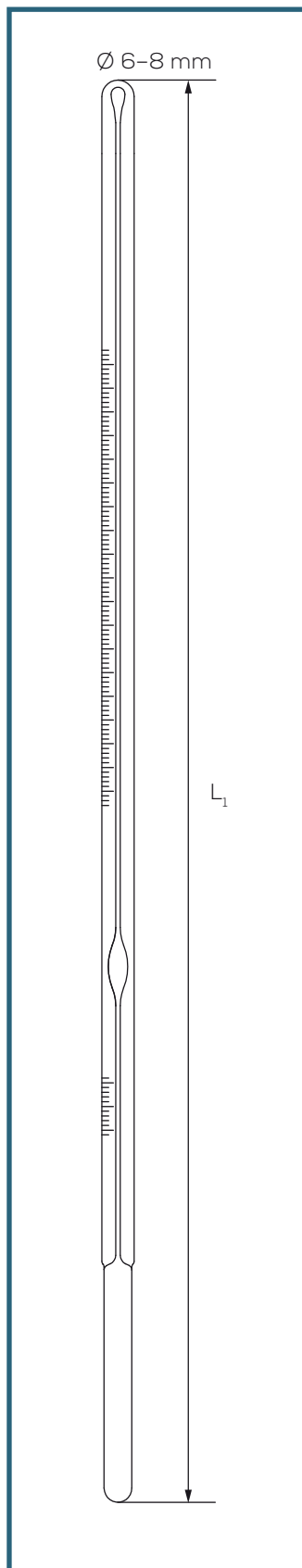

Capillary white back round, Ø 6-8 mm

- + Made in Germany
- + Suitable for calibration
- + With individual serial number & certificate of conformity
- + Each item packed in square plastic sleeve

Order-No.	Type	Measuring Range in °C	Scale in °C	Tolerance in °C	Total Length in mm (L <sub>1</sub> )	Immersion in mm (L <sub>2</sub> )
1202005S	S5C	-38 to +50	1	±0,5	260	108
1202012S	S12C	-20 to +102	0,2	±0,2	435	total
1202015S	S15C	-2 to +80	0,2	±0,2	415	total
1202018S	S18C	+34 to +42	0,1	±0,1	300	total
1202022S	S22C	+95 to +103	0,1	±0,1	300	total
1202056S	S56C	+19 to +35	0,02	±0,1	610	total
1202058S*	S58C	-34 to +49	0,5	±0,3	300	total
1202059S*	S59C	-18 to +82	0,5	±0,3	300	total
1202062S	S62C	-38 to +2	0,1	±0,1	401	total
1202063S	S63C	-8 to +32	0,1	±0,1	401	total
1202064S**	S64C	+25 to +55	0,1	±0,1	401	total
1202065S**	S65C	+50 to +80	0,1	±0,1	401	total
1202066S**	S66C	+75 to +105	0,1	±0,1	401	total
1202067S**	S67C	+95 to +155	0,2	±0,2	401	total
1202091S	S91C	+20 to +50	0,1	±0,1	390	76
1202116S	S116C	+18,9 to +25,1	0,01	±0,1	615	total
1202117S	S117C	+23,9 to +30,1	0,01	±0,1	615	total
1202120S**	S120C	+38,6 to +41,4	0,05	±0,1	300	total
1202130S	S130C	-7 to +105	0,5	±0,5	300	total

\* Capillary form: prismatic

\*\* Thermometer with auxiliary scale at 0 °C

#### ORDER SUFFIX:

...../80 with Safety-coating (FEP)

...../03 with Works-calibration certificate

...../04 with DAkkS-calibration certificate

Please always indicate the required number of calibration points.

Sample: Order-No.: 1202012S/04/3P = ASTM-Thermometer 12C, including DAkkS-calibration certificate with 3 calibration points

Order-No.	Type	Measuring Range in °F	Scale in °F	Tolerance in °F	Total Length in mm (L <sub>1</sub> )	Immersion in mm (L <sub>2</sub> )
1205005S	S5F	-36 to +120	2	±1	260	108
1205012S	S12F	-5 to +215	0,5	±0,3	435	total
1205015S	S15F	+30 to +180	0,5	±0,4	415	total
1205018S	S18F	+94 to +108	0,2	±0,2	300	total
1205022S	S22F	+204 to +218	0,2	±0,2	300	total
1205056S	S56F	+66 to +95	0,05	±0,2	610	total
1205058S*	S58F	-30 to +120	1	±0,5	300	total
1205059S*	S59F	0 to +180	1	±0,5	300	total
1205062S	S62F	-36 to +35	0,2	±0,2	401	total
1205063S	S63F	+18 to +89	0,2	±0,2	401	total
1205064S**	S64F	+77 to +131	0,2	±0,2	401	total
1205065S**	S65F	+122 to +176	0,2	±0,2	401	total
1205066S**	S66F	+167 to +221	0,2	±0,2	401	total
1205067S**	S67F	+203 to +311	0,5	±0,5	401	total
1205130S	S130F	+20 to +220	1	±0,5	300	total

\* Capillary form: prismatic

\*\* Thermometer with auxiliary scale at +32 °F

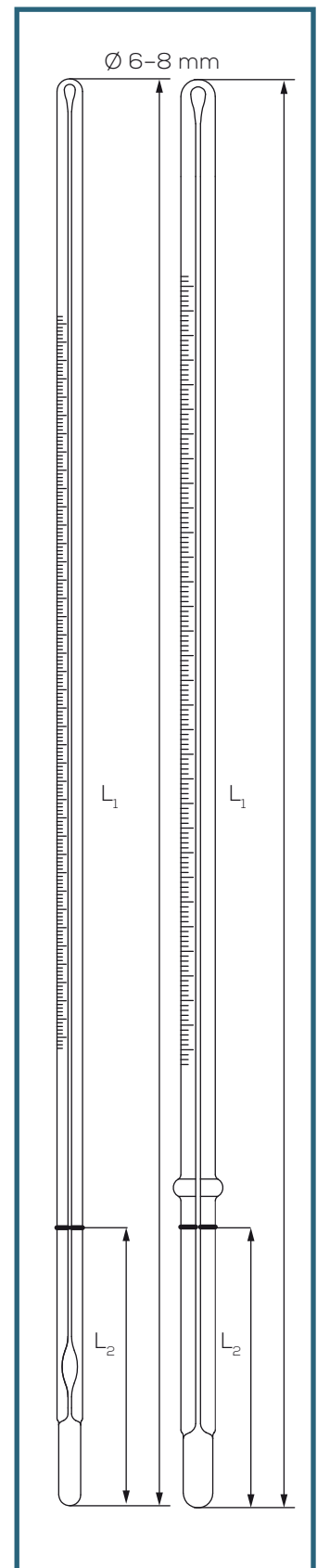

#### ORDER SUFFIX:

...../80 with Safety-coating (FEP)

...../03 with Works-calibration certificate

...../04 with DAkkS-calibration certificate

Please always indicate the required number of calibration points.

Sample: Order-No.: 1205012S/04/3P = ASTM-Thermometer 12F, including DAkkS-calibration certificate with 3 calibration points



# PRECISION LABORATORY THERMOMETERS, STEMFORM, ASTM-LIKE – BLUE FILLING, ACCU-SAFE

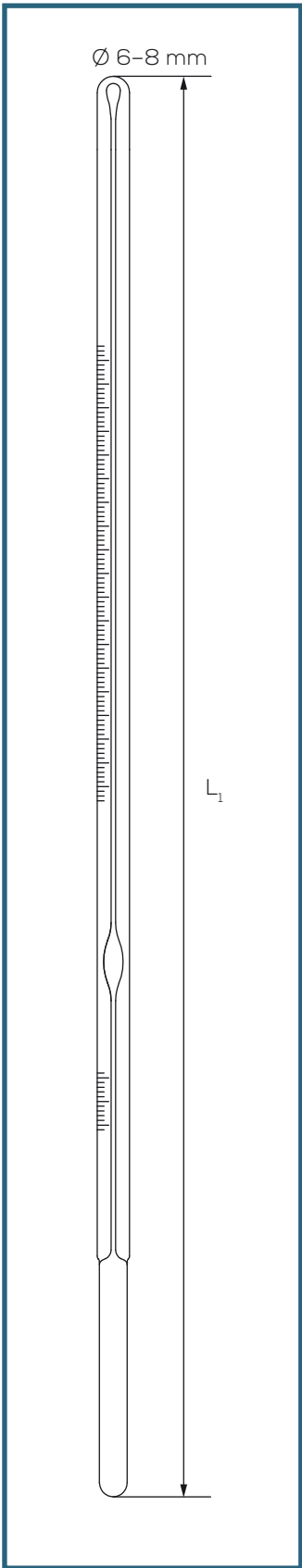

Capillary white back round, Ø 6-8 mm

- + Made in Germany
- + Suitable for calibration
- + With individual serial number & certificate of conformity
- + Each item packed in square plastic sleeve

Order-No.	Like ASTM-Type	Measuring Range in °C	Scale in °C	Tolerance in °C	Total Length in mm (L <sub>1</sub> )	Immersion in mm (L <sub>2</sub> )
1202001S	1C	-20 to +150	1	±0,5	335	76
1202009S	9C	-5 to +110	0,5	±0,5	305	57
1202013S	13C	+155 to +170	0,5	±0,5	175	total
1202014S	14C	+38 to +82	0,1	±0,1	390	79
1202016S	16C	+30 to +200	0,5	±0,3 / above 180 ±1	415	total
1202017S	17C	+19 to +27	0,1	±0,1	300	total
1202019S	19C	+49 to +57	0,1	±0,1	300	total
1202020S	20C	+57 to +65	0,1	±0,1	300	total
1202021S	21C	+79 to +87	0,1	±0,1	300	total
1202023S	23C	+18 to +28	0,2	±0,1	235	90
1202024S	24C	+39 to +54	0,2	±0,1	255	90
1202025S	25C	+95 to +105	0,2	±0,1	235	90
1202026S	26C	+130 to +140	0,1	±0,2	480	total
1202027S	27C	+147 to +182	0,5	±0,5	320	76
1202028S**	28C	+36,6 to +39,4	0,05	±0,1	320	total
1202029S**	29C	+52,6 to +55,4	0,05	±0,1	320	total
1202033S	33C	-38 to +42	0,2	±0,2	435	50
1202034S	34C	+25 to +105	0,2	±0,2	435	50
1202035S	35C	+90 to +170	0,2	±0,4	435	50
1202036S	36C	-2 to +68	0,2	±0,2	420	45
1202037S	37C	-2 to +52	0,2	±0,2	410	100
1202038S	38C	+24 to +78	0,2	±0,2	410	100

\*\* Thermometer with auxiliary scale at 0 °C

**ORDER SUFFIX:**

...../80 with Safety-coating (FEP)

...../03 with Works-calibration certificate

...../04 with DAkkS-calibration certificate

**Please always indicate the required number of calibration points.**

**Sample: Order-No.: 1202001S/04/3P** = Thermometer ASTM-like Type 1C, including DAkkS-calibration certificate with 3 calibration points



Order-No.	Like ASTM-Type	Measuring Range in °C	Scale in °C	Tolerance in °C	Total Length in mm (L <sub>1</sub> )	Immersion in mm (L <sub>2</sub> )
1202039S	39C	+48 to +102	0,2	±0,2	410	100
1202040S	40C	+72 to +126	0,2	±0,2	410	100
1202041S	41C	+98 to +152	0,2	±0,3	410	100
1202042S	42C	+95 to +255	0,5	±1 / above 180 ±2	410	100
1202044S**	44C	+18,6 to +21,4	0,05	±0,1	320	total
1202045S**	45C	+23,6 to +26,4	0,05	±0,1	320	total
1202046S**	46C	+48,6 to +51,4	0,05	±0,1	320	total
1202047S**	47C	+58,6 to +61,4	0,05	±0,1	320	total
1202048S**	48C	+80,6 to +83,4	0,05	±0,1	320	total
1202049S	49C	+20 to +70	0,2	±0,2	320	65
1202052S	52C	-10 to +5	0,1	±0,1	180	total
1202054S	54C	+20 to +100,6	0,2	±0,2	325	total
1202057S	57C	-20 to +50	0,5	±0,5	305	57
1202061S	61C	+32 to +127	0,2	±0,2	400	79
1202071S	71C	-37 to +21	0,5	±0,2	370	76
1202072S**	72C	-19,4 to -16,6	0,05	±0,1	320	total
1202073S**	73C	-41,4 to -38,6	0,05	±0,1	320	total
1202082S	82C	-15 to +105	1	±1	180	30
1202083S	83C	+15 to +70	1	±1	190	40
1202084S	84C	+25 to +80	1	±1	400	249
1202085S	85C	+40 to +150	1	±1	325	181
1202086S	86C	+95 to +175	1	±1	190	35

\*\* Thermometer with auxiliary scale at 0 °C

#### ORDER SUFFIX:

- ...../80 with Safety-coating (FEP)
- ...../03 with Works-calibration certificate
- ...../04 with DAkkS-calibration certificate

Please always indicate the required number of calibration points.

Sample: Order-No.: 1202039S/04/3P = Thermometer ASTM-like Type 39C, including DAkkS-calibration certificate with 3 calibration points

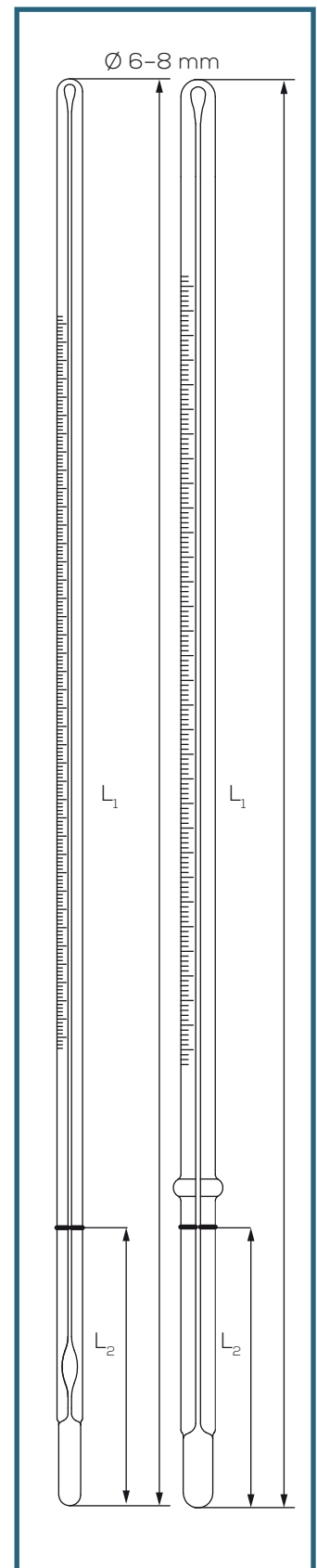

# PRECISION LABORATORY THERMOMETERS, STEMFORM, ASTM-LIKE – BLUE FILLING, ACCU-SAFE

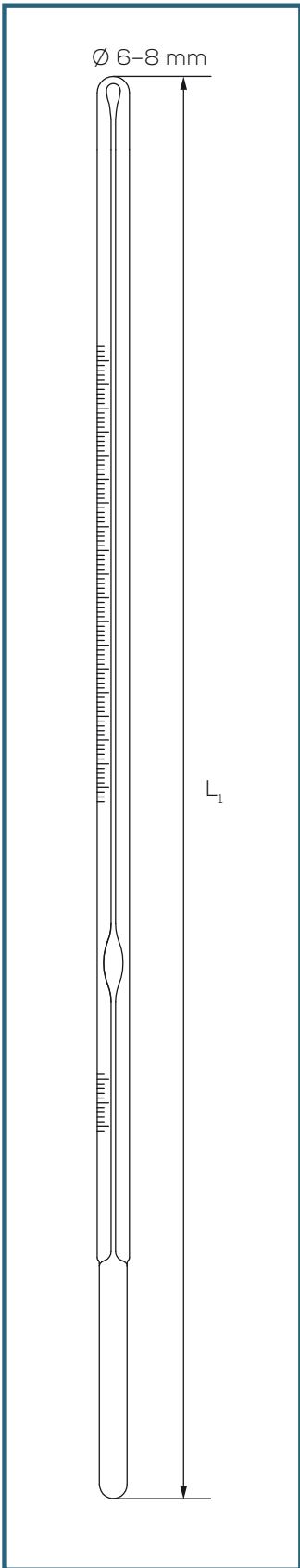

Capillary white back round, Ø 6-8 mm

- + Made in Germany
- + Suitable for calibration
- + With individual serial number & certificate of conformity
- + Each item packed in square plastic sleeve

Order-No.	Like ASTM-Type	Measuring Range in °C	Scale in °C	Tolerance in °C	Total Length in mm (L <sub>1</sub> )	Immersion in mm (L <sub>2</sub> )
1202088S	88C	+10 to +200	1	±1	305	57
1202089S	89C	-20 to +10	0,1	±0,1	390	76
1202090S	90C	0 to +30	0,1	±0,1	390	76
1202092S	92C	+40 to +70	0,1	±0,1	390	76
1202093S	93C	+60 to +90	0,1	±0,1	390	76
1202094S	94C	+80 to +110	0,1	±0,1	390	76
1202095S	95C	+100 to +130	0,1	±0,2	390	76
1202096S	96C	+120 to +150	0,1	±0,2	390	76
1202097S	97C	-18 to +49	0,5	±0,3	320	total
1202098S	98C	+16 to +82	0,5	±0,3	300	total
1202099S	99C	-50 to +5	0,2	±0,2	320	35
1202102S	102C	+123 to +177	0,2	±0,3	410	100
1202103S	103C	+148 to +202	0,2	±0,4	410	100
1202110S**	110C	+133,6 to +136,4	0,05	±0,15	320	total
1202112S**	112C	+4 to +6	0,02	±0,04	230	total
1202113S	113C	-1 to +175	0,5	±0,5	420	total
1202118S**	118C	+28,6 to +31,4	0,05	±0,1	320	total
1202119S**	119C	-38,3 to -30	0,1	±0,2	435	100
1202121S**	121C	+98,6 to +101,4	0,05	±0,1	320	total
1202122S	122C	-45 to -35	0,1	±0,4	320	total
1202123S	123C	-35 to -25	0,1	±0,4	320	total

\*\* Thermometer with auxiliary scale at 0 °C

### ORDER SUFFIX:

- ...../80 with Safety-coating (FEP)
- ...../03 with Works-calibration certificate
- ...../04 with DAkkS-calibration certificate

Please always indicate the required number of calibration points.

Sample: Order-No.: 1202088S/04/3P = Thermometer ASTM-like Type 88C, including DAkkS-calibration certificate with 3 calibration points

Order-No.	Like ASTM-Type	Measuring Range in °C	Scale in °C	Tolerance in °C	Total Length in mm (L <sub>1</sub> )	Immersion in mm (L <sub>2</sub> )
1202124S	124C	-25 to -15	0,1	±0,2	320	total
1202125S	125C	-15 to -5	0,1	±0,2	320	total
1202126S**	126C	-27,4 to -24,6	0,05	±0,1	320	total
1202127S**	127C	-21,4 to -18,6	0,05	±0,1	320	total
1202128S**	128C	-1,4 to +1,4	0,05	±0,1	320	total
1202129S**	129C	+91,6 to +94,4	0,05	±0,1	320	total
1202132S**	132C	+148,6 to +151,4	0,05	±0,2	320	total
1202133S	133C	-38 to +2	0,1	±0,1	395	76
1202134S	134C	+144 to +156	0,2	±0,2	280	100
1202135S	135C	+38 to +93	1	±1	190	40
1202136S	136C	-20 to +60	0,2	±0,15	305	total
1202137S	137C	+80 to +100	0,1	±0,1	270	76

\*\* Thermometer with auxiliary scale at 0 °C

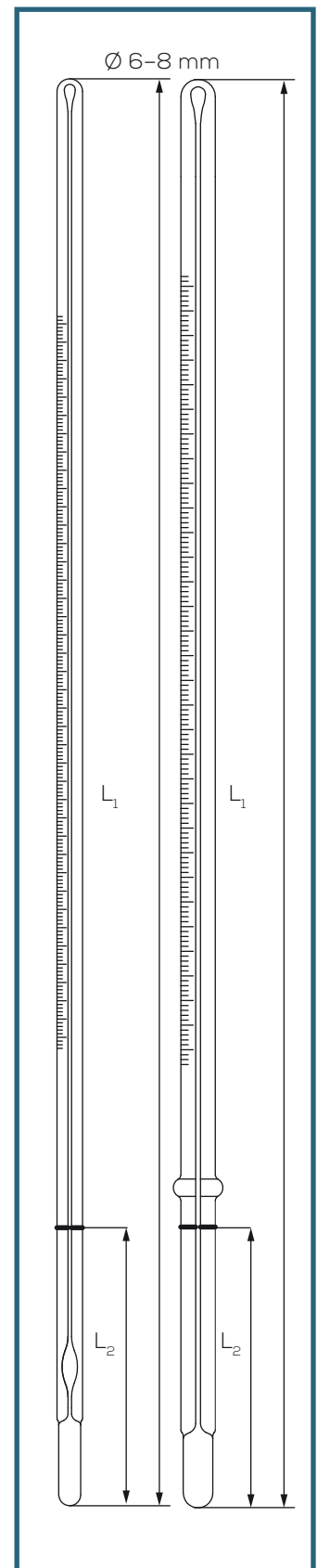

#### ORDER SUFFIX:

- ...../80 with Safety-coating (FEP)
- ...../03 with Works-calibration certificate
- ...../04 with DAkkS-calibration certificate

Please always indicate the required number of calibration points.

Sample: Order-No.: 1202124S/04/3P = Thermometer ASTM-like Type 124C, including DAkkS-calibration certificate with 3 calibration points

# PRECISION LABORATORY THERMOMETERS, STEMFORM, ASTM-LIKE – BLUE FILLING, ACCU-SAFE

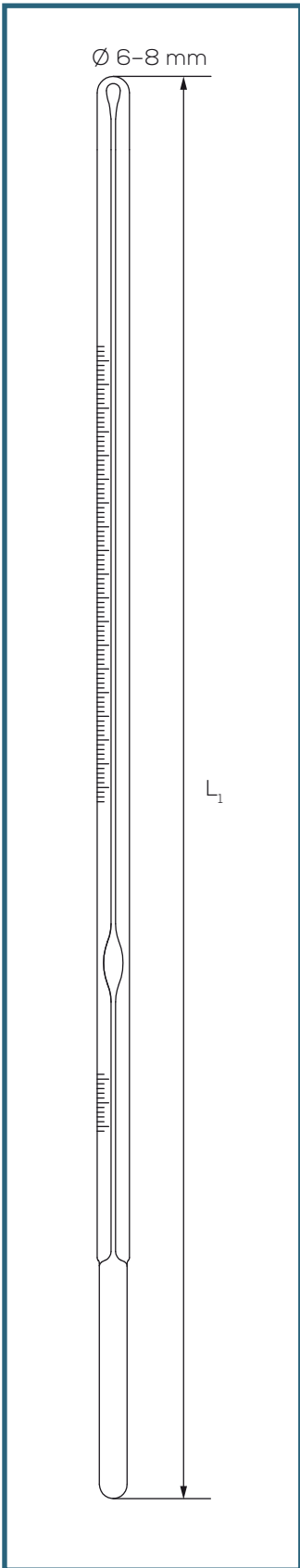

Capillary white back round, Ø 6-8 mm

- + Made in Germany
- + Suitable for calibration
- + With individual serial number & certificate of conformity
- + Each item packed in square plastic sleeves

Order-No.	Like ASTM-Type	Measuring Range in °F	Scale in °F	Tolerance in °F	Total Length in mm (L <sub>1</sub> )	Immersion in mm (L <sub>2</sub> )
1205001S	1F	0 to +302	2	±1	335	76
1205009S	9F	+20 to +230	1	±1	305	57
1205014S	14F	+100 to +180	0,2	±0,2	390	79
1205016S	16F	+85 to +392	1	±0,5 / above 357 ±1	415	total
1205017S	17F	+66 to +80	0,2	±0,2	300	total
1205019S	19F	+120 to +134	0,2	±0,2	300	total
1205020S	20F	+134 to +148	0,2	±0,2	300	total
1205021S	21F	+174 to +188	0,2	±0,2	300	total
1205028S**	28F	+97,5 to +102,5	0,1	±0,2	320	total
1205029S**	29F	+127,5 to +132,5	0,1	±0,2	320	total
1205030S**	30F	+207,5 to +212,5	0,1	±0,2	320	total
1205033S	33F	-36,5 to +107,5	0,5	±0,5	435	50
1205034S	34F	+77 to +221	0,5	±0,5	435	50
1205035S	35F	+194 to +338	0,5	±1	435	50
1205044S**	44F	+66,5 to +71,5	0,1	±0,2	320	total
1205045S**	45F	+74,5 to +79,5	0,1	±0,2	320	total
1202046S**	46F	+119,5 to +124,5	0,1	±0,2	320	total
1205047S**	47F	+137,5 to +142,5	0,1	±0,2	320	total
1205048S**	48F	+177,5 to +182,5	0,1	±0,2	320	total
1205050S	50F	+54 to +101	0,1	±0,2	485	total
1205051S	51F	+69 to +116	0,1	±0,2	485	total
1205054S	54F	+68 to +213	0,5	±0,5	325	total
1205057S	57F	-4 to +122	1	±1	305	57
1205061S	61F	+90 to +260	0,5	±0,5	400	79
1205071S	71F	-35 to +70	1	±0,5	370	76
1205072S**	72F	-2,5 to +2,5	0,1	±0,2	320	total

\*\* Thermometer with auxiliary scale at +32 °F

### ORDER SUFFIX:

- ...../80 with Safety-coating (FEP)
- ...../03 with Works-calibration certificate
- ...../04 with DAkkS-calibration certificate

Please always indicate the required number of calibration points.

Sample: Order-No.: 1205001S/04/3P = Thermometer ASTM-like Type 1F, including DAkkS-calibration certificate with 3 calibration points

Order-No.	Like ASTM-Type	Measuring Range in °F	Scale in °F	Tolerance in °F	Total Length in mm (L <sub>1</sub> )	Immersion in mm (L <sub>2</sub> )
1205073S**	73F	-42,5 to +37,5	0,1	±0,2	320	total
1205075S	75F	-35 to +35	0,5	±0,5	425	100
1205077S	77F	+245 to +265	0,5	±0,5	290	total
1205078S	78F	+295 to +315	0,5	±0,5	290	total
1205079S	79F	+345 to +365	0,5	±0,5	290	total
1205082S	82F	0 to +220	2	±2	180	30
1205083S	83F	+60 to +160	1	±2	190	40
1205084S	84F	+75 to +175	1	±2	400	249
1205085S	85F	+100 to +300	2	±2	325	181
1205086S	86F	+200 to +350	2	±2	190	35
1205088S	88F	+50 to +392	2	±2	305	57
1205097S	97F	0 to +120	1	±0,5	320	total
1205098S	98F	+60 to +180	1	±0,5	300	total
1205099S	99F	-58 to +41	0,5	±0,4	320	35
1205108S	108F	+270 to +290	0,5	±0,5	290	total
1205109S	109F	+320 to +340	0,5	±0,5	290	total
1205110S**	110F	+272,5 to +277,5	0,1	±0,2	320	total
1205113S	113F	+30 to +350	1	±1	420	total
1205118S**	118F	+83,5 to +88,5	0,1	±0,2	320	total
1205119S**	119F	-37 to -22	0,2	±0,4	435	100
1205126S**	126F	-17,5 to -12,5	0,1	±0,2	320	total
1205128S**	128F	+29,5 to +34,5	0,1	±0,2	320	total
1205129S**	129F	+197,5 to +202,5	0,1	±0,2	320	total
1205135S	135F	+100 to +200	1	±2	190	40
1205136S	136F	-5 to +140	0,5	±0,25	305	total

\*\* Thermometer with auxiliary scale at +32 °F

**ORDER SUFFIX:**

- ...../80 with Safety-coating (FEP)
- ...../03 with Works-calibration certificate
- ...../04 with DAkkS-calibration certificate

Please always indicate the required number of calibration points.

Sample: Order-No.:1205075S/04/3P = Thermometer ASTM-like Type 75F, including DAkkS-calibration certificate with 3 calibration points

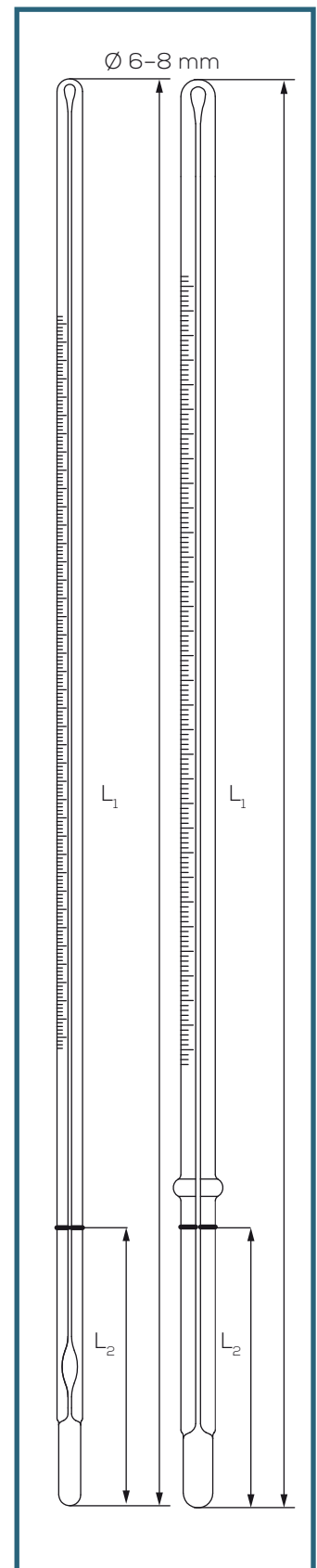

# PRECISION THERMOMETERS, STEMFORM, ISO-R 1770 / BS 1704 BLUE FILLING, ACCU-SAFE

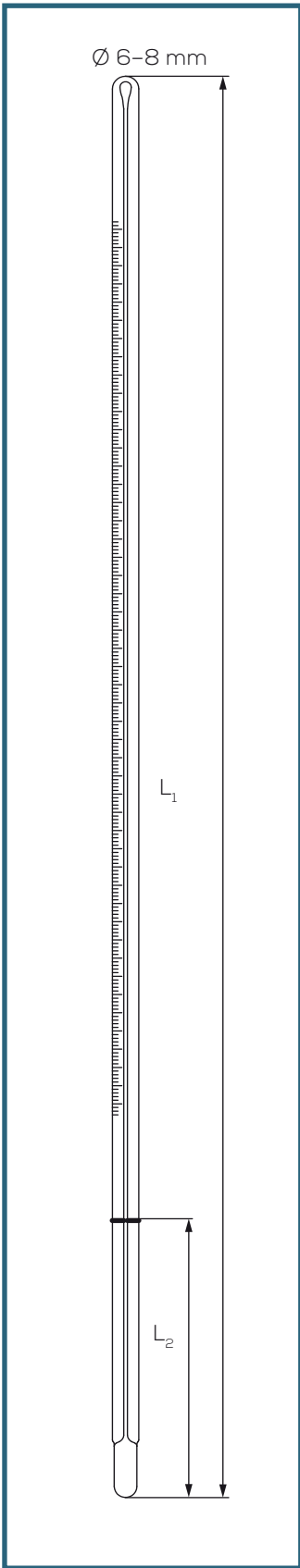

Capillary white back round, Ø 6–8 mm

- + Made in Germany
- + Suitable for calibration
- + With individual serial number & certificate of conformity
- + Each item packed in square plastic sleeves

Order-No.	Similar ISO Type	Measuring Range in °C	Scale in °C	Tolerance in °C	Total Length in mm (L <sub>1</sub> )	Immersion in mm (L <sub>2</sub> )
69351	L/75	-1 to +51	0,1	±0,3	480	75
69352	M/75	-1 to +101	0,1	±0,3	630	75
69353	N/75	-1 to +201	0,2	±0,6	630	75
69354	L/total	-1 to +51	0,1	±0,2	480	total
69355	L/total	-1 to +101	0,1	±0,2	630	total
69356	L/total	-1 to +201	0,2	±0,4	630	total

**ORDER SUFFIX:**  
 ...../80 with Safety-coating (FEP)  
 ...../03 with Works-calibration certificate  
 ...../04 with DAkkS-calibration certificate

Please always indicate the required number of calibration points.  
**Sample: Order-No.: 69351/04/3P** = Thermometer similar to ISO-R 1770, including DAkkS-calibration certificate with 3 calibration points

# PRECISION LABORATORY THERMOMETERS, STEMFORM, IP BLUE FILLING, ACCU-SAFE

Capillary white back round,  $\varnothing$  6–8 mm

- + Made in Germany
- + Suitable for calibration
- + With individual serial number & certificate of conformity
- + Each item packed in square plastic sleeves

Order-No.	Similar IP Type	Measuring Range in °C	Scale in °C	Tolerance in °C	Total Length in mm ( $L_1$ )	Immersion in mm ( $L_2$ )
1212008S	8C	0 to +45	0,2	$\pm 0,2$	350	65
1212038S	38C	+23 to +27	0,1	$\pm 0,1$	270	total
1212039S	39C	-1 to +38	0,1	$\pm 0,1$	450	total
1212042S	42C	-38 to +30	0,5	$\pm 0,5$	380	250
1212049S	49C	-15 to +40	0,5	$\pm 0,25$	325	total
1212050S	50C	+10 to +65	0,5	$\pm 0,25$	325	total
1212051S	51C	+35 to +120	0,5	$\pm 0,5$	325	total
1212053S	53C	0 to +80	0,5	$\pm 0,25$	325	total
1212074S	74C	-35 to +70	0,5	$\pm 0,5 /$ above 0 $\pm 0,2$	325	61
1212075S	75C	-30 to +80	0,5	$\pm 0,5$	325	89
1212076S	76C	+10 to +55	0,5	$\pm 0,25$	250	93
1212091S	91C	0 to +110	1	$\pm 0,5$	215	44
1212100S**	100C	+78,6 to +81,4	0,05	$\pm 0,1$	325	total
2212101S	101C	+20 to +150	1	$\pm 1$	305	57

\*\* Thermometer with auxiliary scale at 0 °C

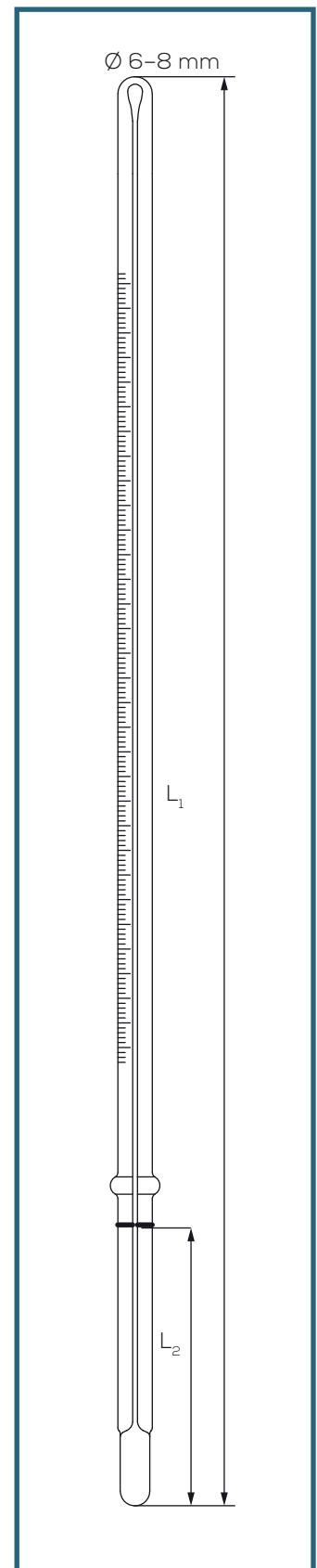

## ORDER SUFFIX:

- ...../80 with Safety-coating (FEP)
- ...../03 with Works-calibration certificate
- ...../04 with DAkkS-calibration certificate

Please always indicate the required number of calibration points.

Sample: Order-No.: 1212008S/04/3P = similar to IP-Thermometer 8C, including DAkkS-calibration certificate with 3 calibration points



# PRECISION THERMOMETERS FOR SPECIAL APPLICATION BLUE FILLING, ACCU-SAFE

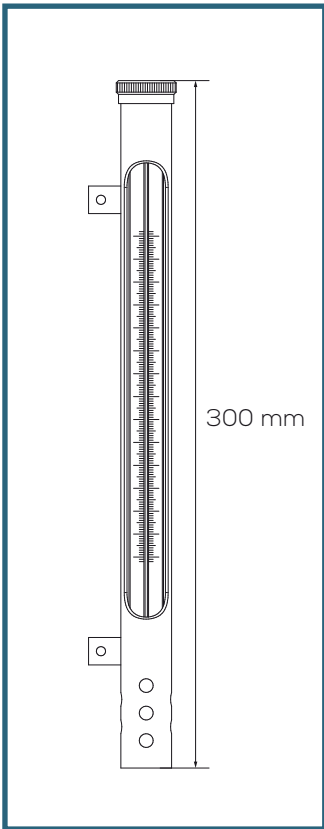

- + Made in Germany
- + Suitable for calibration
- + With individual serial number & certificate of conformity

## PRECISION SHIP THERMOMETER (INSERT) - CLASS II

Capillary colourless prismatic, upper part:  $\varnothing$  18 mm  $\pm$ 0,5 mm with flat scale

Order-No.	Measuring Range in °C	Scale in °C	Tolerance in °C	Total Length in mm
1452101S	-30 to +50	0,5	$\pm$ 0,5	280

### Metal protection case for ship thermometer

Made of brass, with 2 lateral flaps for screw fixing, total length: 300 mm

Order-No.: 1454101

### Ship thermometer complete with metal protection case

Order-No.: 1452101S/1454101

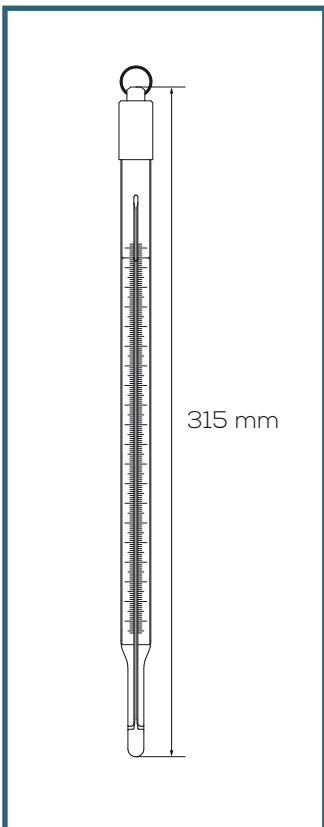

## PRECISION COOLING STORE THERMOMETER

Capillary colourless prismatic, upper part:  $\varnothing$  15 mm  $\pm$ 0,5 mm with flat scale, metal cap and loop

Order-No.	Measuring Range in °C	Scale in °C	Tolerance in °C	Total Length in mm
31805S	-10 to +18	0,2	$\pm$ 0,3	315

### ORDER SUFFIX:

...../03 with Works-calibration certificate

...../04 with DAkkS-calibration certificate

Please always indicate number of required calibration points.

Sample: Order-No.: 31805S/04/3P = Cooling Store Thermometer, including DAkkS-calibration certificate with 3 calibration points

## PRECISION TANK- AND DIPPING-THERMOMETER-INSERTS

Capillary colourless prismatic, upper part:  $\varnothing$  17 mm  $\pm$ 0,5 mm with flat scale

Order-No.	Measuring Range in °C	Scale in °C	Tolerance in °C	Total Length in mm ( $L_1$ )
1182901S	-10 to +50	0,5	$\pm$ 0,5	245
1182902S	-10 to +100	0,5	$\pm$ 0,5	245
1182907S	-10 to +35	0,2	$\pm$ 0,3	245
1182908S	-38 to +50	0,2	$\pm$ 0,3	345
1182909S	-10 to +50	0,2	$\pm$ 0,3	345

### Protection cases with rotatable scale cover

Dipper: Length 75 mm,  $\varnothing$  32 mm, with loop

Order-No.	Material	Upper Part Dimensions in mm	For Insert in mm
1182205	Brass	H 200 x B 20	245
1182207	Brass	H 300 x B 20	345

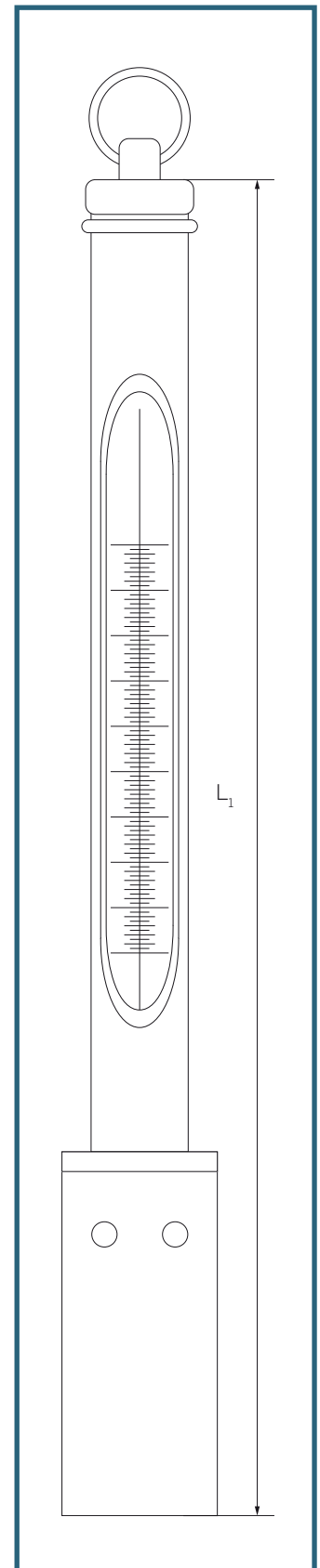

### ORDER SUFFIX:

...../03 with Works-calibration certificate

...../04 with DAkkS-calibration certificate

Please always indicate number of required calibration points.

Sample: Order-No.: 1182901S/04/3P = Precision Tank Thermometer -10 to +50 °C, including DAkkS-calibration certificate with 3 calibration points



## PRECISION LABORATORY THERMOMETERS WITH DAKKS-CALIBRATION – BLUE FILLING, ACCU-SAFE

- + Made in Germany
- + Including DAkkS-calibration certificate with 3 calibration points
- + Traceable to national standards
- + Each item packed in square plastic sleeve

### PRECISION LABORATORY THERMOMETERS, ENCLOSED SCALE

Capillary colourless prismatic, Ø 8-10 mm

Order-No.	Measuring Range in °C	Scale in °C	Total Length in mm	Immersion
1042343S/04/3P	-10 to +50	0,5	220	total
1042344S/04/3P	-10 to +100	0,5	270	total
1042345S/04/3P	-10 to +150	0,5	350	total
1042604S/04/3P	-38 to +50	0,2	400	total
1042346S/04/3P	-5 to +50	0,2	350	total
1042347S/04/3P	-5 to +100	0,2	420	total
1042704S/04/3P	-30 to +30	0,1	400	total
1042349S/04/3P	-10 to +50	0,1	420	total
1042354S/04/3P	0 to +100	0,1	550	total

### PRECISION LABORATORY THERMOMETERS, STEMFORM

Capillary white back round, Ø 6-8 mm

Order-No.	Measuring Range in °C	Scale in °C	Total Length in mm	Immersion
1052105S/04/3P	-38 to +50	0,5	320	total
1042373S/04/3P	-10 to +50	0,5	240	total
1042374S/04/3P	-10 to +100	0,5	290	total
1042375S/04/3P	-10 to +150	0,5	370	total
1042376S/04/3P	-5 to +50	0,2	370	total
1042377S/04/3P	-5 to +100	0,2	440	total
1052303S/04/3P	-38 to +50	0,1	570	total
1132004S/04/3P	0 to +51	0,1	420	total
1132005S/04/3P	+47 to +101	0,1	420	total

### PRECISION LABORATORY THERMOMETERS, STEMFORM, ASTM

Capillary white back round, Ø 6-8 mm

Order-No.	Type	Measuring Range in °C	Scale in °C	Total Length in mm	Immersion in mm
1202005S/04/3P	S5C	-38 to +50	1	260	108
1202012S/04/3P	S12C	-20 to +102	0,2	435	total
1202015S/04/3P	S15C	-2 to +80	0,2	415	total
1202018S/04/3P	S18C	+34 to +42	0,1	300	total
1202022S/04/3P	S22C	+95 to +103	0,1	300	total
1202058S/04/3P	S58C	-34 to +49	0,5	300	total
1202059S/04/3P	S59C	-18 to +82	0,5	300	total
1202062S/04/3P	S62C	-38 to +2	0,1	401	total
1202063S/04/3P	S63C	-8 to +32	0,1	401	total
1202064S/04/3P	S64C	+25 to +55	0,1	401	total
1202065S/04/3P	S65C	+50 to +80	0,1	401	total
1202066S/04/3P	S66C	+75 to +105	0,1	401	total
1202067S/04/3P	S67C	+95 to +155	0,2	401	total
1202091S/04/3P	S91C	+20 to +50	0,1	390	76

# ACCREDITED DAkkS-CALIBRATION LAB FOR TEMPERATURE & DENSITY

More than ever before today's products must provide reliably precise results. Through our DAkkS-calibration laboratory for temperature and density we provide the required reliability – now and in the future.

We measure temperatures from  $-196\text{ °C}$  to  $1,850\text{ °C}$  and vouch for highest precision to all international standards. We document and certify measuring instruments in accordance with the individual requirements of our customers.



## CERTIFIED PRECISION MADE BY LUDWIG SCHNEIDER MESSTECHNIK

In our modern calibration laboratory we offer our clients a wide variety of measurements including documentation:

- + **CALIBRATION TO FIXED POINTS**  
Resistance thermometers
- + **ADJUSTMENT OF**  
digital and analog measured-value  
detection systems
- + **COMPARISON MEASUREMENTS OF**  
Resistance thermometers  
Thermocouples  
Liquid-in-glass thermometers  
Mechanical thermometers  
Block calibrators  
Calibration baths and simulators  
Hydrometers and alcoholmeters

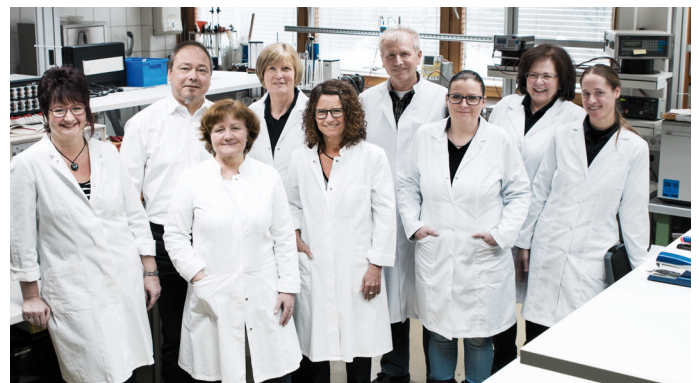

## BEYOND THE USUAL OUR SERVICE PERFORMANCE

From consulting, through calibration, documentation and training up to the development and manufacturing of customized calibration systems we offer you a wide range of services.

Please enter our website for further information:  
[www.kalibrierlabor.org](http://www.kalibrierlabor.org)



LUDWIG  
SCHNEIDER



## PRODUCT SUMMARY

- Catalogue PRECISION LABORATORY THERMOMETERS /  
GROUND JOINT THERMOMETERS

---

- Catalogue PRECISION THERMOMETERS FOR MATERIAL TESTING ASTM, ETC.

---

- Catalogue GENERAL PURPOSE THERMOMETERS /  
THERMOMETERS FOR SPECIAL APPLICATION

---

- Catalogue CABLE-TEMPERATURE PROBES

---

- Catalogue RESISTANCE THERMOMETERS AND THERMOCOUPLES

---

- Catalogue ACCU-SAFE

---

- Catalogue PRECISION THERMOMETERS FOR METEOROLOGY

---

- Catalogue ENGINE THERMOMETERS

---

- Catalogue PRECISION HYDROMETERS

LUDWIG SCHNEIDER  
GMBH & CO. KG

Am Eichamt 4-6  
D-97877 Wertheim  
T +49 9342 8560-0  
F +49 9342 84671

info@ludwig-schneider.de  
www.ludwig-schneider.com